

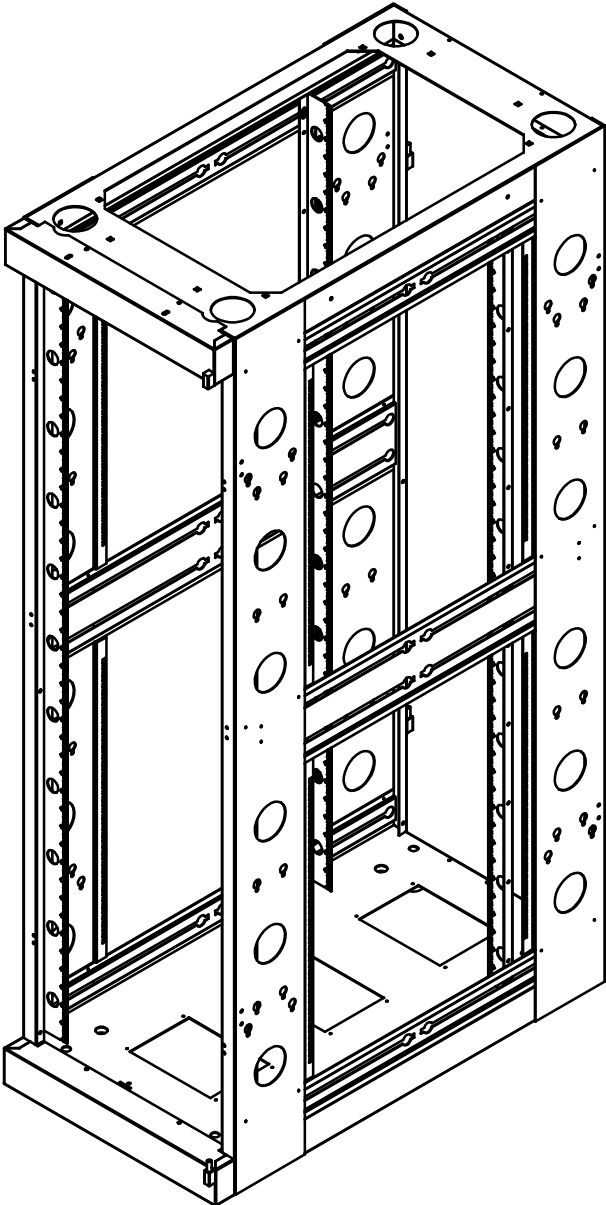

-	New Release	AAH	
Rev.	Description	By	Date
REVISIONS			
			
Material	Part Desc. CORE CABINET		
	Part No. UCC217742		
	Customer		
UNLESS SPECIFIED ALL DIMENSIONS ARE OUTSIDE			Scale
DO NOT SCALE THIS DRAWING			Sht 1 of 8

TOLERANCE	Activity	Name	Date
.0 +/- .03	ANG	DRAWN R.Ibbotson	04.24.08
.00 +/- .015	+/- .5 deg.	CHK.	
.000 +/- .005		APPR.	



-	New Release	AAH	
Rev.	Description	By	Date
REVISIONS			
			
Material	Part Desc. CORE CABINET		
	Part No. UCC217742		
	Customer		
UNLESS SPECIFIED ALL DIMENSIONS ARE OUTSIDE			Scale
DO NOT SCALE THIS DRAWING			Sht 2 of 8

TOLERANCE	Activity	Name	Date
.0 +/- .03	ANG	DRAWN R.Ibbotson	04.24.08
.00 +/- .015	+/- .5 deg.	CHK.	
.000 +/- .005		APPR.	

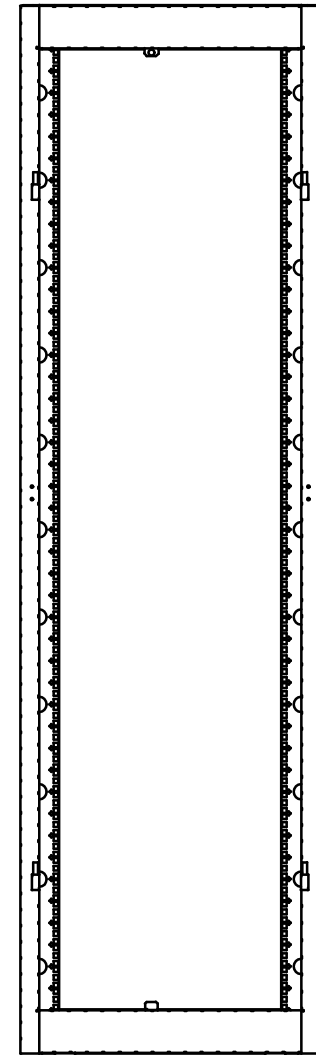
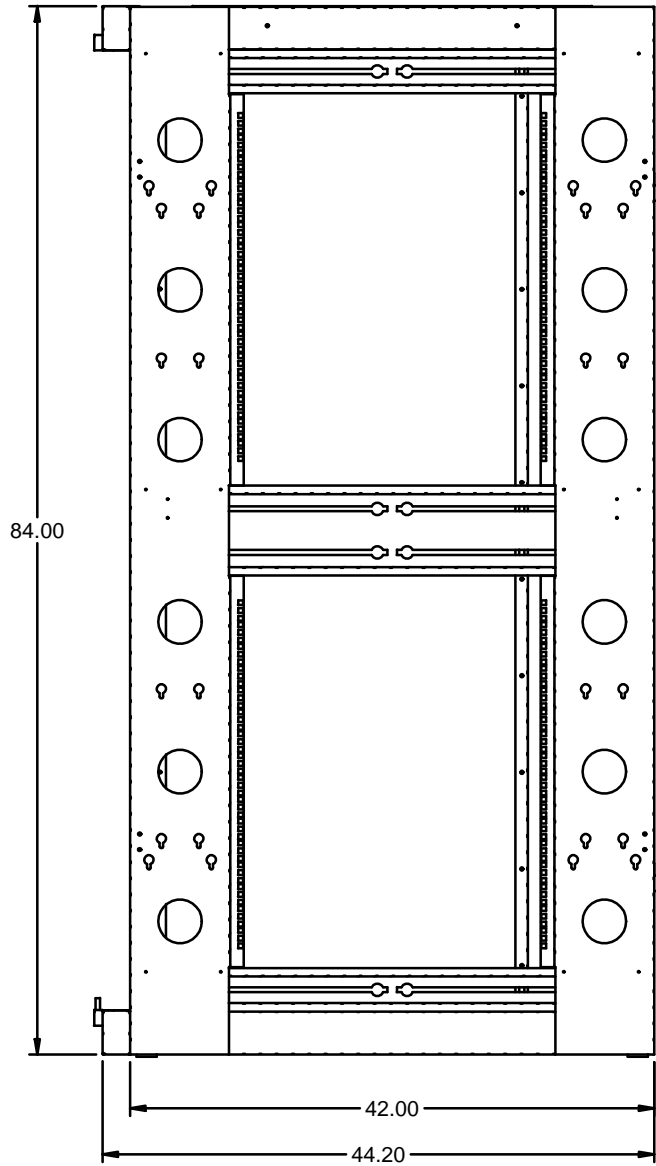
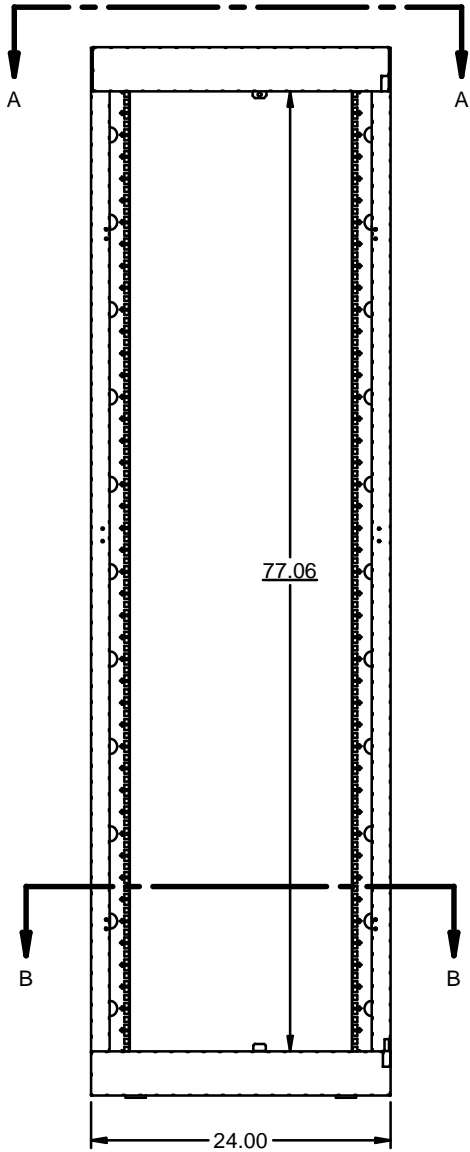

TOLERANCE		Activity	Name	Date
.0	+/- .03	ANG	DRAWN R.Ibbotson	04.24.08
.00	+/- .015	deg.	CHK.	
.000	+/- .005		APPR.	

-	New Release	AAH	
Rev.	Description	By	Date
REVISIONS			
			
Material	Part Desc. CORE CABINET		
	Part No. UCC217742		
	Customer		
UNLESS SPECIFIED ALL DIMENSIONS ARE OUTSIDE			Scale
DO NOT SCALE THIS DRAWING			Sht 3 of 8

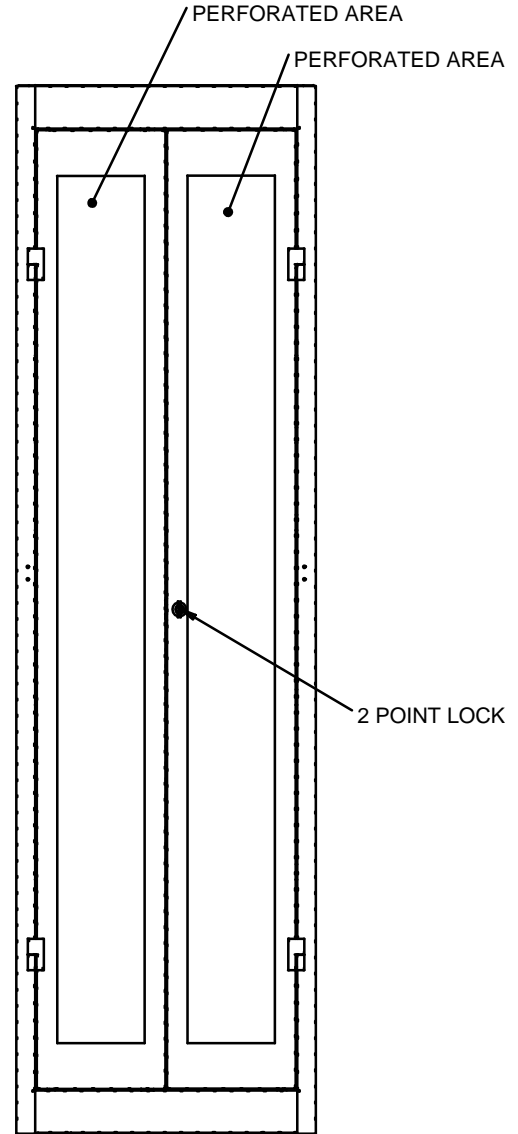
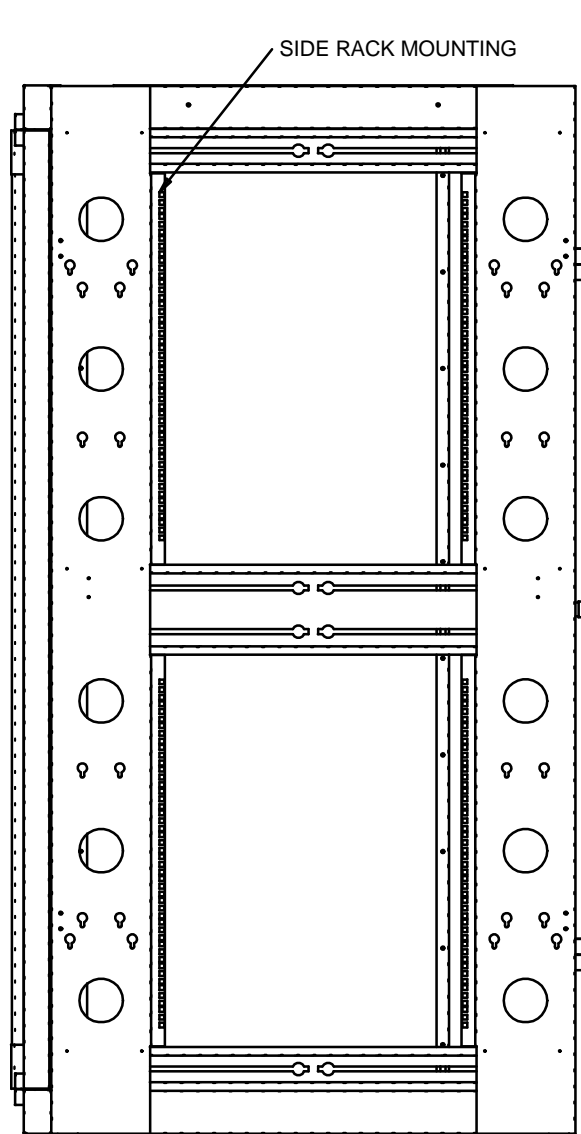
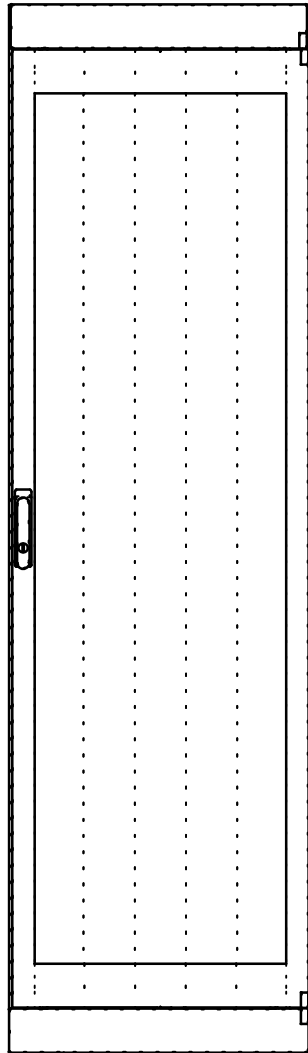

-	New Release	AAH	
Rev.	Description	By	Date
REVISIONS			
			
Material	Part Desc. CORE CABINET		
	Part No. UCC217742		
	Customer		
UNLESS SPECIFIED ALL DIMENSIONS ARE OUTSIDE			Scale
DO NOT SCALE THIS DRAWING			Sht 4 of 8

TOLERANCE	Activity	Name	Date
.0 +/- .03	ANG	DRAWN R.Ibbotson	04.24.08
.00 +/- .015	+/- .5 deg.	CHK.	
.000 +/- .005		APPR.	

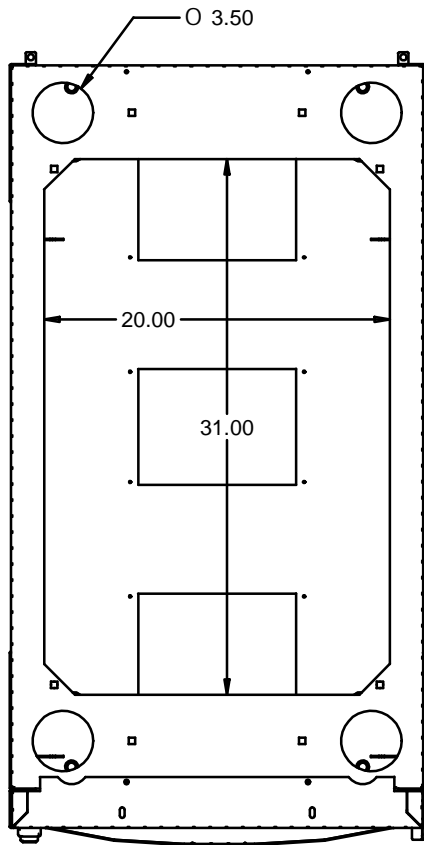

SECTION A-A

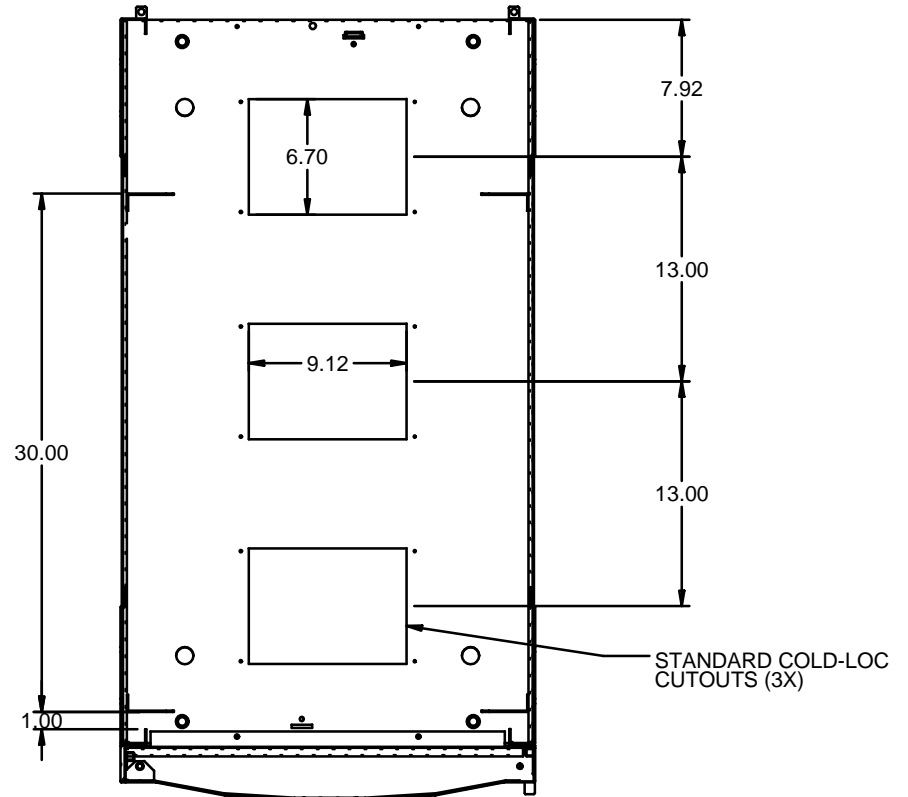

SECTION B-B

-	New Release	AAH	
Rev.	Description	By	Date
REVISIONS			
			
Material	Part Desc. CORE CABINET		
	Part No. UCC217742		
	Customer		
UNLESS SPECIFIED ALL DIMENSIONS ARE OUTSIDE			Scale
DO NOT SCALE THIS DRAWING			Sht 5 of 8

TOLERANCE	Activity	Name	Date
.0 +/- .03	ANG	DRAWN R.Ibbotson	04.24.08
.00 +/- .015	+/- .5 deg.	CHK.	
.000 +/- .005		APPR.	

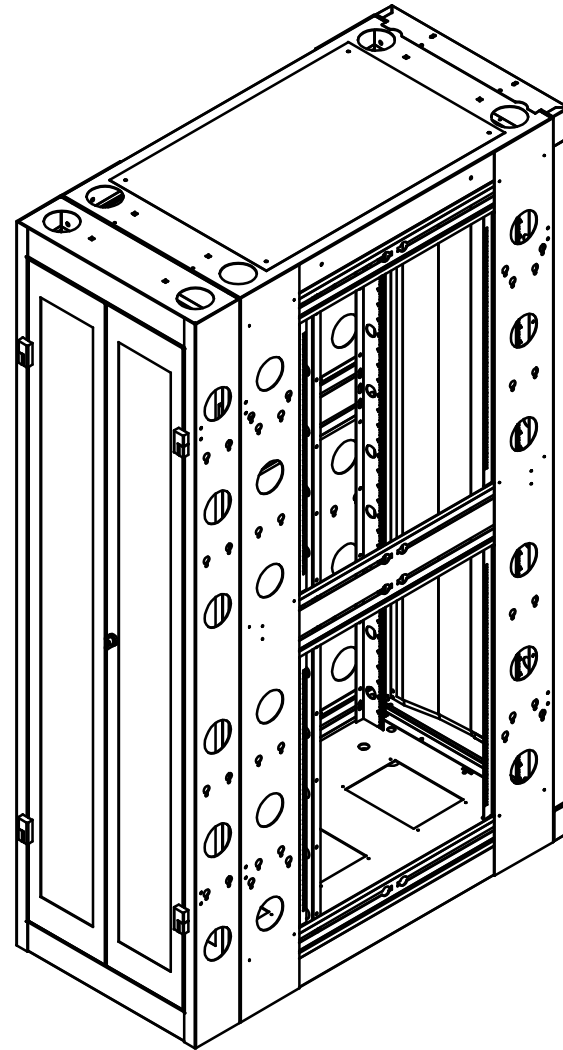
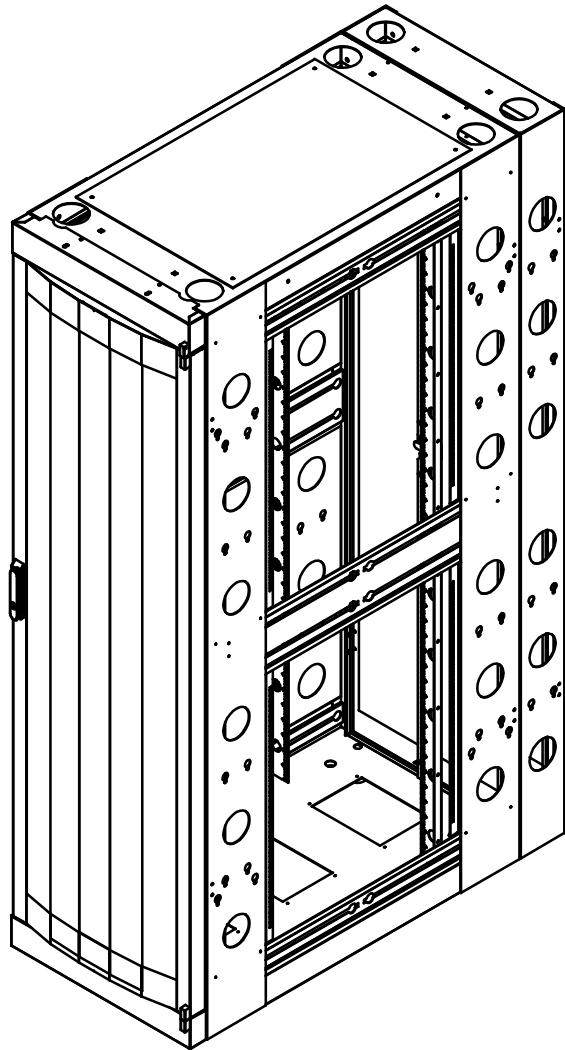

TOLERANCE	Activity	Name	Date
.0 +/- .03	ANG	DRAWN R.Ibbotson	04.24.08
.00 +/- .015	+/- .5 deg.	CHK.	
.000 +/- .005		APPR.	

-	New Release	AAH	
Rev.	Description	By	Date
REVISIONS			
			
Material	Part Desc. CORE CABINET		
	Part No. UCC217742		
	Customer		
UNLESS SPECIFIED ALL DIMENSIONS ARE OUTSIDE			Scale
DO NOT SCALE THIS DRAWING			Sht 6 of 8

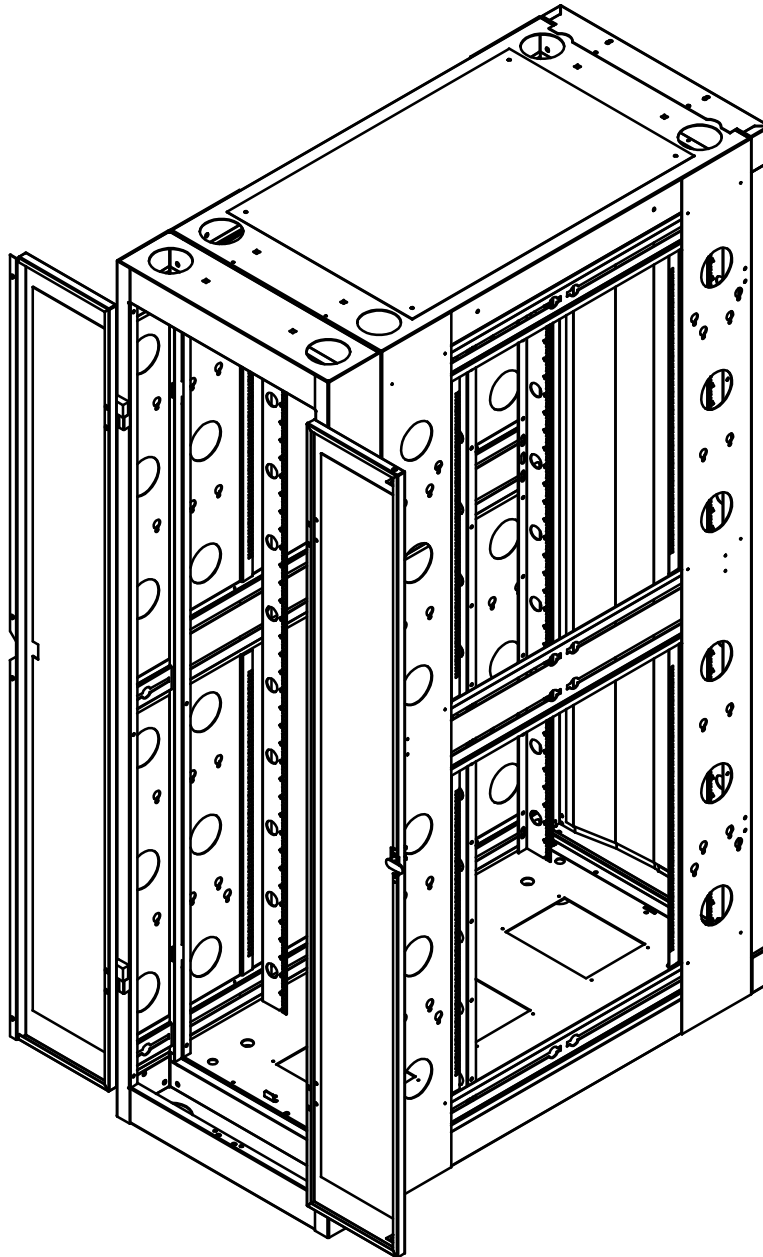

-	New Release	AAH	
Rev.	Description	By	Date
REVISIONS			
			
Material	Part Desc. CORE CABINET		
	Part No. UCC217742		
	Customer		
UNLESS SPECIFIED ALL DIMENSIONS ARE OUTSIDE			Scale
DO NOT SCALE THIS DRAWING			Sht 7 of 8

TOLERANCE	Activity	Name	Date
.0 +/- .03	ANG	DRAWN R.Ibbotson	04.24.08
.00 +/- .015	+/- .5 deg.	CHK.	
.000 +/- .005		APPR.	

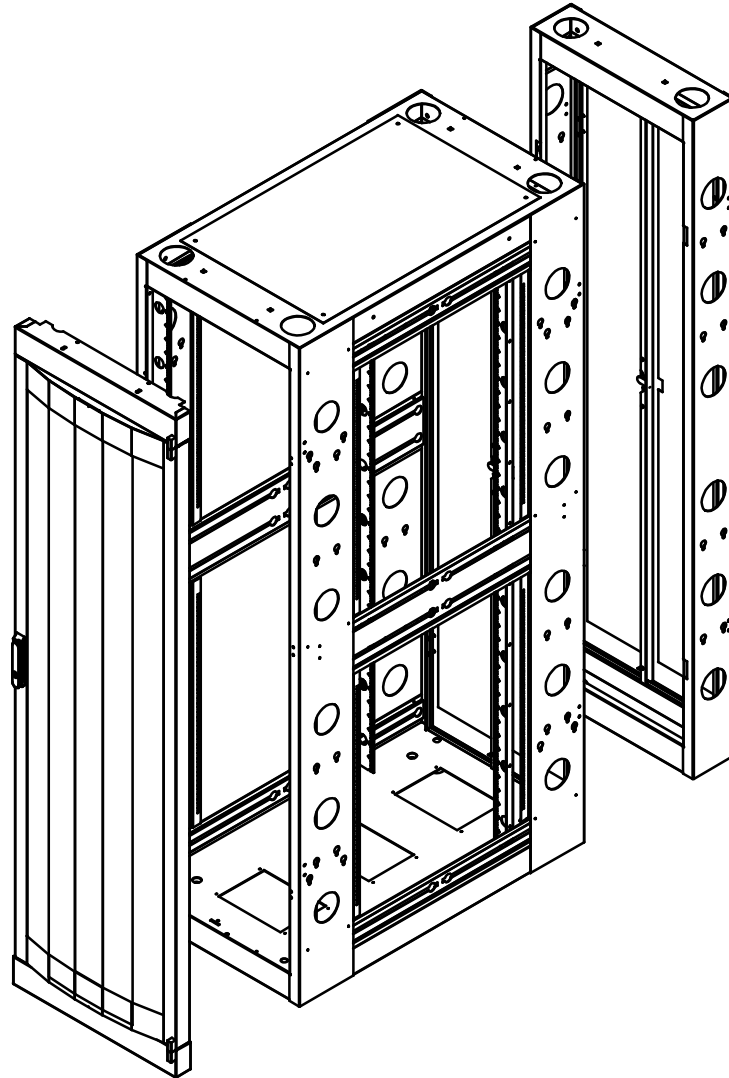

-	New Release	AAH	
Rev.	Description	By	Date
REVISIONS			
			
Material	Part Desc. CORE CABINET		
	Part No. UCC217742		
	Customer		
UNLESS SPECIFIED ALL DIMENSIONS ARE OUTSIDE			Scale
DO NOT SCALE THIS DRAWING			Sht 8 of 8

TOLERANCE	Activity	Name	Date
.0 +/- .03	ANG	DRAWN R.Ibbotson	04.24.08
.00 +/- .015	+/- .5 deg.	CHK.	
.000 +/- .005		APPR.	